

# OWNER'S MANUAL

DO NOT REMOVE PRIOR TO SALE

## INFLATABLE PERSONAL FLOTATION DEVICE (PFD)

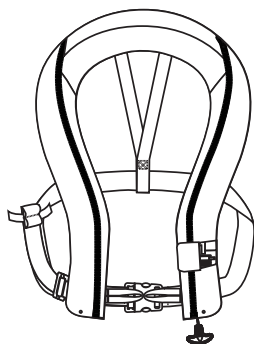

### SAILING (38g cylinder)

ZH1H

Type V/II Automatic/Manual Inflatable PFD with Sailing Harness

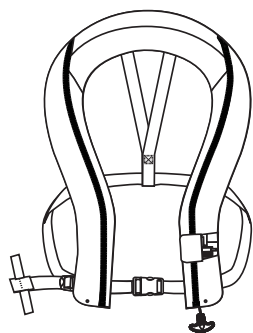

### POWER BOATING (38g cylinder)

Z1H

Type II Automatic/Manual Inflatable PFD

ZD1H

Type II Automatic/Manual Inflatable PFD (with dual side adjustment)

### NOTICE:

For initial arming of the PFD. See instructions provided with the cylinder.

### WARNING!

This PFD will not float you without inflation! Each CO2 inflator body will only inflate the PFD once. You must rearm this PFD after each use of the CO2.

## Approval Conditions and Carriage Regulations

This inflatable PFD is approved by the U.S. Coast Guard for use as a Type indicated on the cover. It is not approved for water skiing or other high impact, high speed activities. This inflatable was designed to be more comfortable and less restrictive to wear than inherently buoyant PFDs. When worn, used, and serviced according to this owner's manual, this PFD can greatly increase your chances of survival in the water. NOT recommended for non-swimmers or weak swimmers. Users of inflatable PFDs must be at least 16 years old.

## Mandatory Carriage Requirements

Federal regulations in 33 CFR 175-1993 require you to carry Coast Guard approved personal flotation devices (PFDs) legibly marked with the Coast Guard approval number which are in good and serviceable condition and are the correct size for each person on board. To be considered serviceable, this PFD shall not exhibit deterioration that could diminish its performance such as broken or deformed hardware, detached webbing, rotted structural components, air leaks, or non-functional oral inflation tube. Unless worn inflated, this PFD must also be properly armed with a full CO2 cylinder, inflation system status indicator, and an accessible manual inflation lanyard. A PFD which is "approved only when worn" or "required to be worn" must be worn under the specified conditions.

## Specifications:

User Weight:	More than 80 pounds
Chest size:	30 to 56 inches
Age Limitation:	16 years of age and older

ZH1H:        Rearming Kit        V95000-86202Z

Z1H:         Rearming Kit        V95000-86202Z

ZD1H:        Rearming Kit        V95000-86202Z

**WARNING!** Use only the rearming kit stipulated above for use with your PFD. Rearming kits and parts are not interchangeable. Substitution may damage or cause your PFD to malfunction.

**Deluxe Automatic: ZH1H and Z1H**

ZH1H includes an integrated safety harness, making the USCG approval conditions different for this model.

Features: 38 lbs design buoyancy

Halkey-Roberts Corp. single point indicator automatic inflation system (1H).

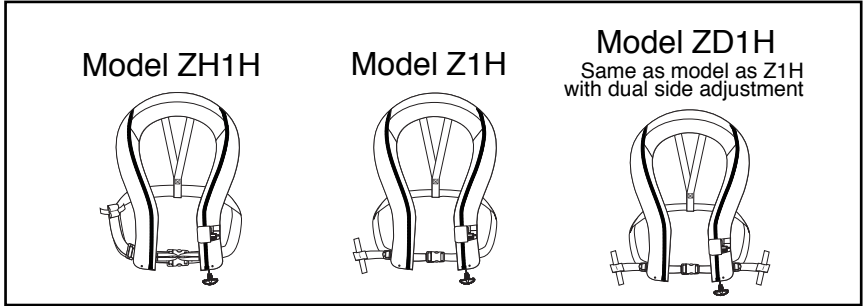

# INSTRUCTIONS FOR USE

## 1. Where and How to Check Inflation System Status Indicators:

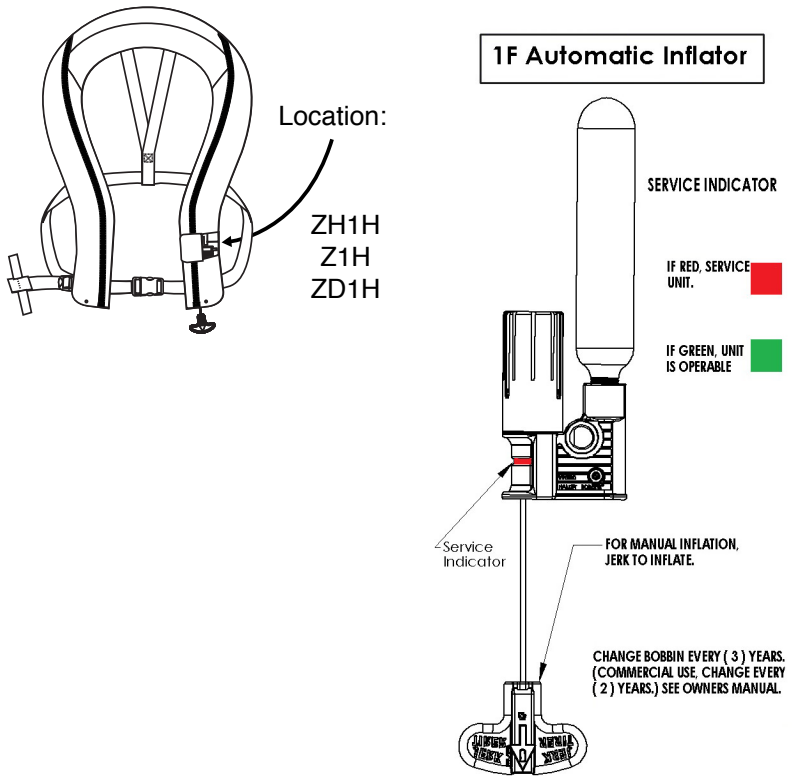

## 2. Donning Instructions: DON LIKE A VEST

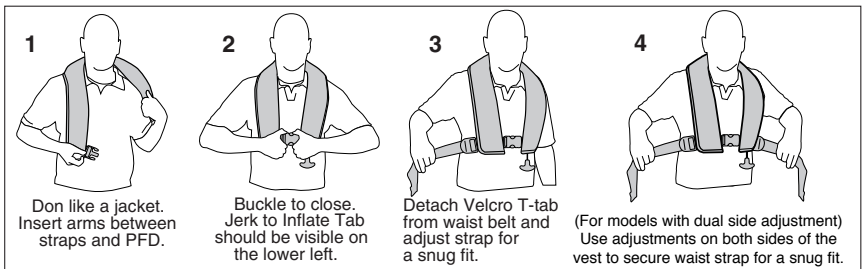

It's imperative that the inflatable PFD is properly adjusted to fit the person wearing it. An incorrect fit, or improper donning can inhibit the effectiveness of the device, or result in injury. Do not wear inflatable PFDs underneath any type of clothing, serious injury may result.

### 3. Inflation and Deflation

#### INFLATION

CO2 Inflation (Automatic/Manual PFD) The PFD will inflate when fully immersed in water. Automatic/Manual PFDs can be manually inflated by grasping the manual inflation pull tab and pulling sharply downward.

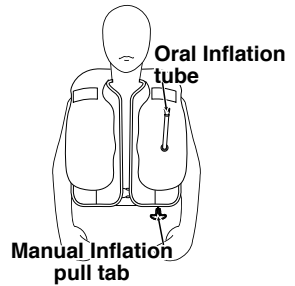

CO2 inflation (Manual Inflation PFD) The PFD is manually inflated by grasping the manual inflation pull tab and pulling sharply downward.

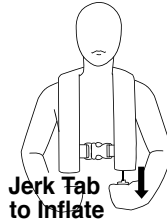

Oral Inflation: The oral inflation tube is located inside the cover on the wearer's left side. To inflate orally, access the inflation tube by opening the top portion of the cover, remove the dust cap, and blow air into the tube until the inflatable is firm.



Note: Oral inflation can be used to test for air leakage or as a back-up in the event that the CO2 cylinder fails to operate. CO2 gas permeates the bladder more quickly than air, and therefore oral inflation can be used to refill the bladder in the event the wearer is in the water for an extended period. **Do not fully inflate the PFD orally and then inflate with CO2 cylinder as bladder could incur damage.**

#### DEFLATION

The deflation tab is located on top of the dust cap. Turn the dust cap upside down and insert the deflation mechanism into the oral tube. Hold the deflation mechanism in place with your finger and gently squeeze all the air out of the PFD. If the PFD has inflated while being worn, it may be necessary to partially deflate the PFD in order to remove it.



To remove all air, roll the PFD into a ball and squeeze while operating the deflation mechanism. The PFD will be difficult to fold and re-pack properly if not completely deflated.

**PRACTICE** wearing and adjusting your inflatable PFD in the water in order to be prepared for an emergency!

Practice wearing and inflating your PFD using different types of clothing. Wade into the water and manually inflate, or allow your PFD to inflate automatically. Practice until you have complete confidence in the and performance of your PFD.

# Halkey-Roberts Pro 1F® V95000

## Service Instructions

### DISASSEMBLY

(see figure)

**Step 1:** Unpack or open the life vest so that the manual/automatic inflator is visible.

**Step 2:** Remove gas CO2 cylinder by rotating cylinder counterclockwise then pull out. **Discard cylinder.**

**Step 3:** Remove cap by turning counter-clockwise.

**Step 4:** Remove bobbin from cap or housing unit. **Discard bobbin** (yellow). Check the housing to be sure it is clear and dry.

Note: The bobbin (yellow) body may remain in the housing or in the cap assembly when you remove the cap. The bobbin body must be removed prior to Rearming.

### REARMING

**Note: Rearming must follow the sequence below.**

**Step 5:** A new bobbin must be used. New bobbin must have been purchased within three ( 3 ) years. If bobbin purchase date is unknown, check date on bobbin, replace if over three (3) years.

**Step 6:** **IMPORTANT!**  
Bobbin (yellow) must be installed into the HOUSING (\*\*see figure), white side up, aligning the slots on the bobbin with the ridges inside the threaded housing. The bobbin will slide in easily if installed correctly.

**Step 7:** Install cap by screwing clockwise until it meets the housing shoulder.

Note: No gap between the cap and the housing shoulder.

**Step 8:** Check the new cylinder to be sure it has not been punctured.

### **IMPORTANT!**

Install the bobbin and cap before installing a new cylinder.

**Step 9:** Install new cylinder by engaging the cylinder threads with the inflator threads. Turn cylinder clockwise till a firm seal is achieved.



**WARNING: PFD WILL ONLY INFLATE IF**  
**CYLINDER IS TURNED TO FULL STOP.**

**Step 10:** Check to be sure service indicator is **GREEN.**

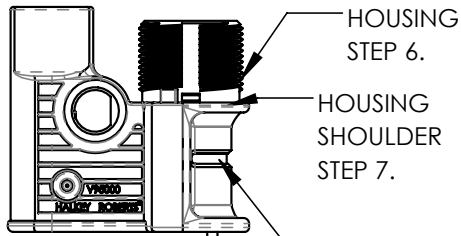
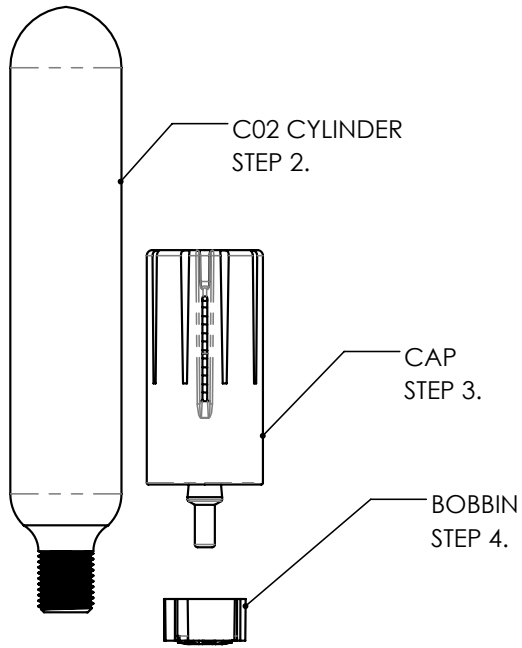

### SERVICE INDICATOR



If green, unit is operable.



If red, stop and service unit.

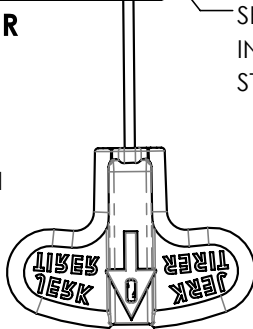

# RE-PACKING INSTRUCTIONS

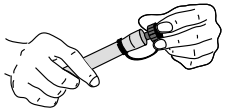

- 1** PRESS DOWN ON ORAL TUBE.  
PRESS ON BLADDER TO DEFLATE  
ALL THE AIR.

- 2** RETURN ZIPPER TO  
THE PIN BOX ON THE  
OPPOSITE SIDE OF  
THE VEST.

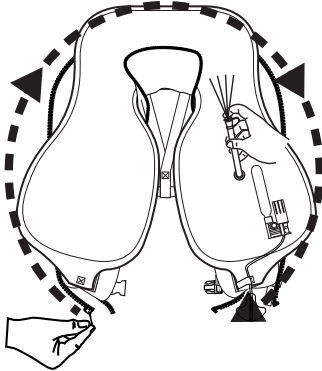

- 3** TUCK OUTSIDE EDGES  
OF BLADDER UNDER.  
POSITION THE INFLATOR  
MECHANISM SO IT IS VISIBLE  
ON THE TOP OF THE BLADDER.

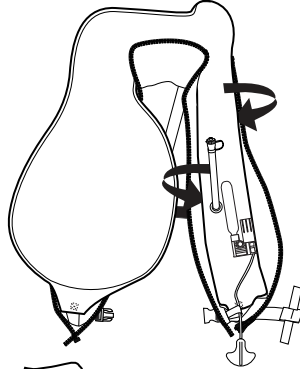

- 4** WHEN STARTING TO CLOSE  
ZIPPER MAKE SURE "JERK  
TO INFLATE" CORD IS PLACED  
BENEATH ZIPPER PIN BOX .

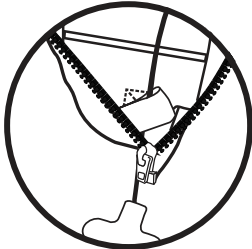

- 5** WHILE FOLDING BLADDER  
ZIP SHELL FULLY CLOSED.

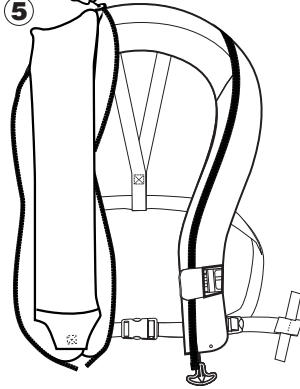

- 6** ZIPPER SHOULD BE FULLY  
CLOSED. MAKE SURE INFLATER  
MECHANISM IS VISIBLE  
THROUGH THE WINDOW.

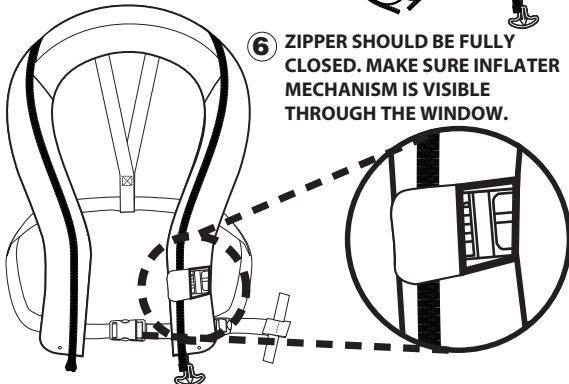



# PRECAUTIONS FOR USE IN FREEZING TEMPERATURES

The gas in a CO2 cartridge expands in hot weather and contracts in cold weather.

At 30 degrees F (-1 degrees C) the bladder fill is 87% of the volume created at 70 degrees F (22 degrees C).

Under freezing conditions the CO2 fills more slowly and achieves less buoyancy.

This can be compensated by partly inflating the PFD with one or two breaths of air through the oral tube.

Caution: Do not fully inflate by blowing in the oral tube and then inflate with the CO2 cylinder.

Repeated CO2 inflation after oral inflation may damage the PFD.

## ***IS YOUR PFD IN GOOD AND SERVICEABLE CONDITION?***

Check your PFD between outings to be sure that it is properly armed; that it is free of rips, tears or holes; that all seams are securely sewn; and that the fabric, straps and hardware are still strong. Inspect the inflatable portion of the PFD in accordance with the Care and Maintenance Instructions below.

## ***CARE AND MAINTENANCE INSTRUCTIONS***

### **1. Visually Inspect and Check for Leaks**

For check for leaks, remove cylinder, orally inflate the device until firm, and leave overnight. There should be no noticeable loss of firmness. Perform this leakage test at the beginning of each season and at least every 2 months during usage.

2. Rearming Instructions: Page 5 & 6.

3. Refolding Instructions: Page 7.

4. FOR ALL MODELS, THE CO2 CARTRIDGE MAY BE USED ONLY ONE TIME TO INFLATE THE PFD.

5. USE ONLY THE REARMING KIT INDICATED FOR YOUR PFD MODEL. SEE PAGE 1.

6. Store in well-ventilated area away from direct sunlight.

- Hand wash in clear water and hang to dry
- DO NOT DRY CLEAN or use solvent based cleaners

## **WHY ARE PFDs REQUIRED SAFETY EQUIPMENT?**

Drownings are the leading cause of fatalities involving recreational boating. A PFD provides flotation to help keep your head above water, help you to stay face up in the water, and increase your chances for survival and rescue. Most adults only need an extra 7 to 12 pounds of flotation to keep their heads above water. The proper size PFD will properly support the weight of the wearer.

Since this inflatable PFD does not have inherent buoyancy, it provides inflation only when inflated. Familiarize yourself with the use of this PFD so you know what to do in an emergency.

## **HOW AND WHY TO TEST YOUR PFD?**

Inflate your PFD and try it out in the water to:

- Make sure it floats you:
  - Comfortably (when worn properly)
  - Adequately for expected wave conditions (Body shapes/ densities affect performance)
- Make sure it works:
  - A flow of bubbles should not appear (See “Visually Inspect and Leak Test your PFD on page 8)
  - It should inflate quickly and easily
- Learn how it works by:
  - Activating the CO2 inflation system
  - Rearming the CO2 inflation system
  - Using the Oral inflator tube

The U.S. Coast Guard recommends that you purchase two rearming kits. One to be used immediately to test the inflation system and the other to carry onboard as a spare.

Note: Since you should replace the water sensing element each year, the U.S. Coast Guard recommends you test the automatic inflation system in-the-water at the beginning of each season. By doing this, you demonstrate that the automatic inflation system is still working properly and reduce the likelihood of premature inflation and its associated dangers. The only check of the manual inflation system (with CO2 cylinder and green indicator tab removed) would be to determine that the lever arm and piercing pin move freely when moving the lever several times down and up.

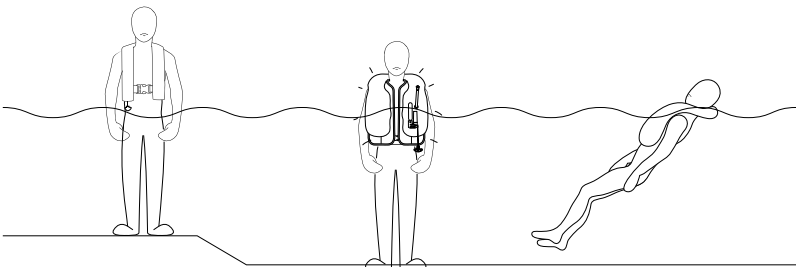

## **HOW DO YOU TEST YOUR PFD USING THE AUTOMATIC INFLATOR?**

1. To test your inflatable PFD, you will need:
  - Your fully armed PFD, and
  - Rearming kit approved for your PFD
2. Put on the PFD.
3. Get into shallow water, just deep enough that you can stand with your head above the surface. Once the inflator is under water the PFD should automatically, fully inflate within 10 seconds.
4. See if the PFD will float you on your back or just slightly back of vertical. In a relaxed floating position, verify that your mouth is well above the water's surface. Note the effect of where you hold your legs on how you float.
5. Get out of the water and remove the PFD. Remove the used CO2 cylinder and the used water sensing element from the PFD inflator. Deflate the PFD using the oral inflator.
6. Let the PFD dry thoroughly. REARM and REPACK the PFD in accordance with the instructions on page 5, 6 and 7.

## **HOW DO YOU TEST YOUR PFD USING THE MANUAL INFLATOR?**

1. To test your inflatable PFD, you will need:
  - Your fully armed PFD, and
  - Rearming kit approved for your PFD
2. Put on the PFD.
3. Actuate the inflation system by jerking firmly downward on the pull tab. The PFD should inflate within 5 seconds.
4. Get into shallow water, just deep enough that you can stand with your head above the surface.
5. See if the PFD will float you on your back or just slightly back of vertical. In a relaxed floating position, verify that your mouth is well above the water's surface. Note the effect of where you hold your legs on how you float.
6. Get out of the water and remove the PFD. Remove the used CO2 cylinder from the PFD inflator. Deflate the PFD using the oral inflator.
7. Let the PFD dry thoroughly. REARM and REPACK the PFD in accordance with the instructions on page 5, 6 and 7.

## **HOW DO YOU TEST YOUR PFD USING THE ORAL INFLATOR?**

1. To test your inflatable PFD, you will not need any spare parts, or rearming kits.
2. Remove the CO2 cylinder, to prevent inadvertent activation of the manual inflation system which could potentially damage the PFD. Inspect the threaded end to confirm that it is unused.
  - 2a. If mechanism is automatic, remove bobbin.
3. Put on the PFD
4. Get into shallow water, just deep enough that you can stand with your head above the surface.
5. If you are a weak swimmer or non-swimmer, inflate the PFD partially so that you are supported well enough to be able to complete inflation without touching bottom, either orally or manually. Note this level of inflation because it is the minimum needed for you to safely use this inflatable PFD.
6. Fully inflate the PFD using the oral inflator.
7. See if the PFD will float you on your back or just slightly back of vertical. In a relaxed floating position, verify that your mouth is well above the water's surface. Note the effect of where you hold your legs on how you float.
8. Get out of the water and remove the PFD. Completely deflate the PFD using the oral inflator.
9. Let the PFD dry thoroughly. REARM AND REPACK the PFD in accordance with the instructions on page 5, 6 and 7.

### **WEAR YOUR PFD!**

In approximately 80% of all boating fatalities, the victims were not wearing a PFD. Most fatal accidents happen on calm sunny days. This inflatable PFD is much more comfortable to wear than other PFD types. Get into the habit of wearing this PFD. Non-swimmers and children especially should wear a hybrid or non-inflatable PFD at all times when on or near the water.

## **HYPOTHERMIA**

Prolonged exposure to cold water causes a condition known as hypothermia – a substantial loss of body heat which leads to exhaustion and unconsciousness. Most drowning victims first suffer from hypothermia. The following chart shows the effects of hypothermia:

### **HOW HYPOTHERMIA AFFECTS MOST ADULTS**

<b><i>Water Temperature °C (F)</i></b>	<b><i>Exhaustion or Unconsciousness</i></b>	<b><i>Expected Time of Survival</i></b>
0.3 (32.5)	UNDER 15 MIN	UNDER 15 to 45 MIN
0.3 to 4 (32.5 to 40)	15 to 30 MIN	30 to 90 MIN
4 to 10 (40 to 50)	30 to 60 MIN	1 to 3 HOURS
10 to 16 (50 to 60)	1 to 2 HOURS	1 to 6 HOURS
16 to 21 (60 to 70)	2 to 7 HOURS	2 to 40 HOURS
21 to 27 (70 to 80)	2 to 12 HOURS	3 HOURS to INDEFINITE
over 27 (over 80)	INDEFINITE	INDEFINITE

PFDs can increase survival time because they allow you to float without using energy treading water and because of their insulating properties. Naturally, the warmer the water, the less insulation you will require. When operating in cold water below 60 F (15.6 C) you should consider using a coat or jacket style PFD or a Type V Thermal Protective PFD as they cover more of the body than the vest or belt style PFDs.

### **Some points to remember about Hypothermia Protection:**

1. Always wear your PFD. Even if you become incapacitated due to hypothermia, the PFD will keep you afloat and greatly improve your chances of rescue.
2. Do not attempt to swim unless it is to reach a nearby craft, fellow survivor, or a floating object on which you can lean or climb. Swimming increases the rate of body heat loss. In cold water, drown-proofing methods that require putting your head in the water are not recommended. Keep your head out of the water. This will lessen heat loss and increase your survival time.
3. Use the standard H.E.L.P. position when wearing an inflatable PFD, drawing the legs up to a seated position, because doing so will help you conserve body heat.
4. Keep a positive attitude about your survival and rescue. This will improve your chances of extending your survival time until rescued. Your will-to-live does make a difference!
5. If there is more than one person in the water, huddling is recommended while waiting to be rescued. This action tends to reduce the rate of heat loss and thus increase the survival time.

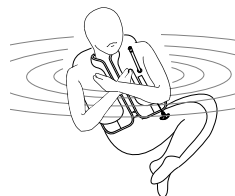

## **IMPORTANT SAFETY HARNESS INFORMATION:**

### **PERMISSIBLE SAFE BODY SIZES FOR MODEL ZH1H INFLATABLE PFD WITH INTEGRAL SAFETY HARNESS**

1. Minimum height = 5 ft 5"
2. Permissible chest range = 30" to 56"

**WARNING:** Safety harnesses are designed to be worn at the chest area, to provide the wearer with the least injury potential, should the user be subject to sudden high shock loads. The harness belt must always be worn at least 2" ABOVE the lowest rib measured from the top of the belt. Failure to correctly wear the safety harness may result in serious injury, or even death.

**NOTE:** The harness must be worn snugly about the body to insure proper fit under all conditions. Failure to do so, materially increases the possibility of injury to the user.

**ALERT!** Under no circumstances should the safety harness be used in any climbing task or activity. Failure to comply with this restriction in use may result in serious injury or death.

Use of a safety harness to prevent falls overboard presents additional risks in case of capsizing or sinking. Do not attach the harness to the boat with a tether greater than 6 ft. 6 in. (200cm) Use only quick-release-under-load hardware. To release the tether from the harness, pull the quick-release pin out and away from the tether buckle.

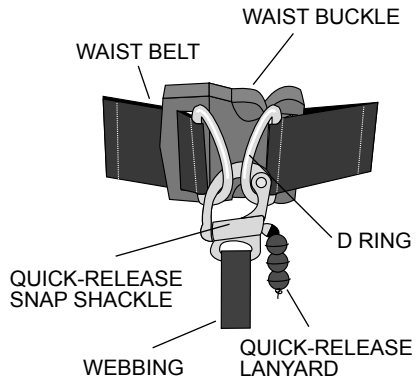

U.S. Coast Guard Approval does not apply to this harness!

**SAFETY HARNESS MAINTENANCE:** Check harness parts and attachment stitching carefully before each use. Do not use harness if there is indication of damage or deterioration.



## ***EACH OF THESE DEVICES IS INTENDED TO HELP YOU SAVE YOUR OWN LIFE:***

For your PFD to function properly, follow these suggestions to verify that it fits, floats, and remains in good condition.

1. Check the inflation mechanism status indicators before each use.
2. Get in the habit of rearming the inflation mechanism right after each inflation.
3. Try your wearable PFD on and adjust it until it fits comfortably in and out of the water.
4. Mark your PFD with your name if you are the only wearer.
5. Do not alter your PFD. If it doesn't fit properly, get one that does. An altered device is not longer Coast Guard approved.
6. Your PFD is not intended for use as a fender or kneeling pad.
7. If your PFD is wet, allow it to dry thoroughly before storing it. Store it in a well-ventilated area.
8. Do not dry your PFD in front of a radiator or other source of direct heat.

### ***ADDITIONAL INFORMATION:***

If you need more information about PFDs and safe recreational boating, contact your state boating authority, U.S. Coast Guard Auxiliary, U.S. Power Squadron, Red Cross, or your nearest unit of the U.S. Coast Guard; or the free boating course number 1-800-336-BOAT (in VA, 1-800-245-BOAT).

### ***DO NOT ATTACH PFD'S TO THE BOAT\****

Each PFD has straps, hooks, buckles, or other means for securing the device in place on the wearer. Some PFDs also incorporate decorative dee rings or tabs. Such items are not to be used to attach the device to the boat. Attaching the device to the boat will not permit it to perform as needed.

\*Safety harness D-rings on models ZH1H is designed to be attached to be fastened to the boat. See instructions on page 13 of the Manual.