

product specifications for:

Day/Night Solar Vent

Item #: N20803W (White)
N20803S (Stainless)

Description

3" Day/Night Solar Vent

Battery Specifications

Capacity: 2500mAh
Voltage: 4.8V

Material Specifications

Body: ABS
Gasket(s): Neoprene
Gasket Thickness: 1/8" (3mm)
Exterior: Stainless Steel (N20803S only)

Performance

Airflow 800 ft³ / 23 m³ per hour

Standards and Certifications

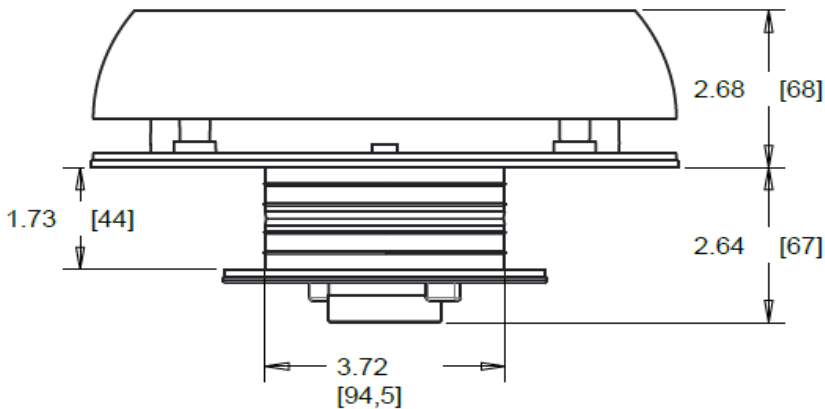

Dimensions: inches [mm]
Drawing not to scale.

toll free 800.307.6702 | marinco.com

